

OmniSwitch 6850 Series

Getting Started Guide

Warning. Only personnel knowledgeable in basic electrical and mechanical procedures should install or maintain this equipment.

Lithium Batteries Caution. There is a danger of explosion if the Lithium battery in your chassis is incorrectly replaced. Replace the battery only with the same or equivalent type of battery recommended by the manufacturer. Dispose of used batteries according to the manufacturer's instructions. The manufacturer's instructions are as follows:

Return the module with the Lithium battery to Alcatel-Lucent. The Lithium battery will be replaced at Alcatel-Lucent's factory.

The features and specifications described in this guide are subject to change without notice.

Copyright © 2007 by Alcatel-Lucent. All rights reserved. This document may not be reproduced in whole or in part without the express written permission of Alcatel-Lucent.

Alcatel-Lucent® and the Alcatel-Lucent logo are registered trademarks of Alcatel-Lucent. Xylan®, OmniSwitch®, OmniStack®, and Alcatel-Lucent OmniVista® are registered trademarks of Alcatel-Lucent.

OmniAccess™, Omni Switch/Router™, PolicyView™, RouterView™, SwitchManager™, VoiceView™, WebView™, X-Cell™, X-Vision™, and the Xylan logo are trademarks of Alcatel-Lucent.

This OmniSwitch product contains components which may be covered by one or more of the following U.S. Patents:

- U.S. Patent No. 6,339,830
- U.S. Patent No. 6,070,243
- U.S. Patent No. 6,061,368
- U.S. Patent No. 5,394,402
- U.S. Patent No. 6,047,024
- U.S. Patent No. 6,314,106
- U.S. Patent No. 6,542,507
- U.S. Patent No. 6,874,090

Alcatel-Lucent 

Alcatel-Lucent
26801 West Agoura Road
Calabasas, CA 91301
(818) 880-3500 FAX (818) 880-3505

US Customer Support: (800) 995-2696
International Customer Support: (818) 878-4507
Internet: service.esd.alcatel-lucent.com

Table of Contents

OmniSwitch 6850 Series	1
Related Documentation	2
Installing the Hardware	3
Items Required	3
Site Preparation	3
Environmental Requirements	3
Electrical Requirements	3
NEBS GR-1089 Compliance Requirements	3
Weight Considerations	4
Items Included	5
Unpacking and Initial Setup	5
Unpacking the Chassis	5
Recommendations	5
Instructions	5
Setting Up the Switch	6
Airflow Considerations	6
Installation Options	7
Installing the Switch on a Tabletop or Bench	7
Tabletop Mounting Steps	7
Rack-Mounting the Switch	8
Rack Mounting Steps	8
Installing Combo Port SFPs	10
Installing Backup Power Supply Components	10

Connections and Cabling	11
Connecting the Serial Cable	11
Serial Connection Default Settings	11
Booting OmniSwitch 6850 Series Switches	12
Booting a Standalone Switch	12
Your First Login Session	14
Logging in to the Switch	14
Assigning an IP Address to the Switch	15
Unlocking Session Types	16
Changing the Login Password	17
Setting the System Time Zone	18
Setting the Date and Time	18
Setting Optional System Information	18
Specifying an Administrative Contact	18
Specifying a System Name	19
Specifying the Switch's Location	19
Viewing and Saving Changes	19

Files and Directories	20
Boot and Image Files	20
boot.params File	20
boot.cfg File	20
Image Files	21
Working and Certified Directories	22
Working Directory	22
Certified Directory	23
Using WebView	26
Browser Compatibility	26
Logging In to WebView	26
Navigating WebView	27
Online Help	29
Additional Information	29
Troubleshooting	30

OmniSwitch 6850 Series

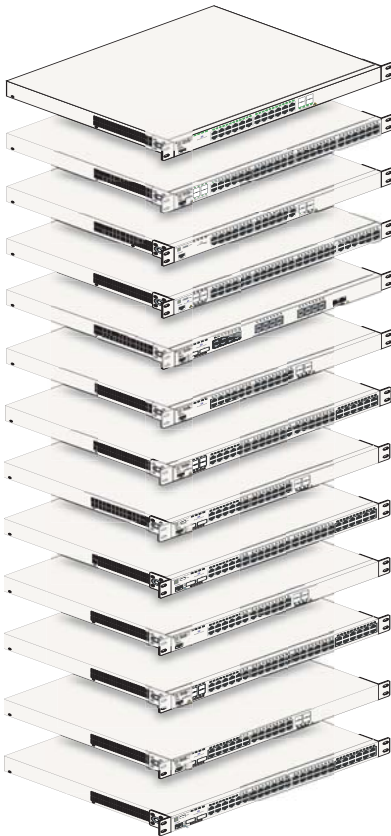

OmniSwitch 6850-24L

OmniSwitch 6850-48L

OmniSwitch 6850-P24L

OmniSwitch 6850-P48L

OmniSwitch 6850-U24X

OmniSwitch 6850-24

OmniSwitch 6850-48

OmniSwitch 6850-24X

OmniSwitch 6850-48X

OmniSwitch 6850-P24

OmniSwitch 6850-P48

OmniSwitch 6850-P24X

OmniSwitch 6850-P48X

The OmniSwitch 6850 Series is an advanced fixed configuration family of Ethernet switches. These switches provide wire rate Layer 2 forwarding and Layer 3 routing with advanced services.

They are fixed configuration, triple-speed (10/100/1000) switches that provide increased network performance, improved application response times, secure the LAN, and enhance user productivity by maximizing mobility, network capacity, and services over existing category 5/5E/6 cabling.

Refer to the User Manual CD for additional hardware and software OmniSwitch documentation.

Related Documentation

The following are the titles and descriptions of all the OmniSwitch 6850 Series user documentation included in the User Manual CD:

- *OmniSwitch 6850 Series Getting Started Guide*

Describes the hardware and software procedures for getting an OmniSwitch 6850 Series switch up and running. Also provides information on fundamental aspects of OmniSwitch hardware components and software architecture.

- *OmniSwitch 6850 Series Hardware Users Guide*

Complete technical specifications and procedures for all OmniSwitch 6850 Series hardware, including chassis, power supplies, fans, combo ports, stacking procedures, optional backup power supplies, etc.

- *OmniSwitch CLI Reference Guide*

Complete reference to all CLI commands supported on the OmniSwitch 6850 Series. Includes syntax definitions, default values, examples, usage guidelines, and CLI-to-MIB variable mappings.

- *OmniSwitch 6800/6850/9000 Switch Management Guide*

Includes procedures for readying a switch for integration into a network. Topics include the software

directory architecture, image rollback protections, authenticated switch access, managing switch files, system configuration, using SNMP, and using web management software (WebView).

- *OmniSwitch 6800/6850/9000 Network Configuration Guide*

Includes network configuration procedures and descriptive information on all the major software features and protocols included in the base software package. Chapters cover Layer 2 information (Ethernet and VLAN configuration), Layer 3 information (static routes), security options (authenticated VLANs), Quality of Service (QoS), and link aggregation.

- *OmniSwitch 6800/6850/9000 Advanced Routing Configuration Guide*

Includes network configuration procedures and descriptive information on all the software features and protocols included in the advanced routing software package. Chapters cover multicast routing (DVMRP and PIM-SM) and OSPF.

- *OmniSwitch Transceivers Guide*

Includes information on Small Form Factor Pluggable (SFPs) and 10 Gbps Small Form Factor Pluggables (XFPs) transceivers.

Installing the Hardware

Items Required

In addition to the materials and components provided in the OmniSwitch 6850 Series shipment, you must provide the following items in order to complete this installation:

- Grounding wrist strap
- Phillips screwdriver
- Serial cable
- Rack mount screws, if applicable

Site Preparation

Environmental Requirements

OmniSwitch 6850 Series switches have the following environmental and airflow requirements:

- The installation site must maintain a temperature between 0° and 45° Celsius (32° and 113° Fahrenheit) and not exceed 95 percent maximum humidity (non-condensing) at any time.
- Be sure to allow adequate room for proper air ventilation and access at the front, back, and sides of the switch. No clearance is necessary at the top or bottom of the chassis. Refer to [page 6](#) for minimum clearance requirements.

Electrical Requirements

OmniSwitch 6850 Series switches have the following general electrical requirements:

- Each switch requires one grounded AC power source.
- Grounded AC power source must be 110V for North American installations (220V international).
- Each supplied AC power cord is approximately 2 meters (6.5 feet) long. Do not use extension cords.

NEBS GR-1089 Compliance Requirements

The following notes and warnings apply to all NEBS compliant platforms.

Grounding requirements: To ground the equipment properly, connect a Panduit Corporation UL listed Lug, P/N: LCD8-10AL to the two threaded holes located on the rear of each chassis and power supply module. All connections should be made using 8AWG copper conductors.

Use Panduit Corporation, P/N: CT-940CH for crimping. (Each Module must have its own grounding conductor.)

(GR-1089 requires treatment of ground connections and painted surfaces as needed during installation.)

All surfaces that are used for intentionally grounding the EUT shall be brought to a bright finish and an anti oxidant solution must be applied to the surfaces being joined.

Non-conductive coatings (such as lacquer and enamel) must be removed from threads and other contact surfaces to assure electrical conductivity.

(Thread forming screws with paint piercing washers may be used for this purpose during installation)

Warning. The intra-building interfaces of this platform, including Gigabit Ethernet, are suitable for connection to intra-building or unexposed wiring or cabling only with shielded and grounded cables at both ends. The intra-building ports of the equipment must not be metallically connected to interfaces that connect to the OSP or its wiring.

Note. All bare conductors must be coated with an appropriate antioxidant compound before crimp connections are made. All unplated connectors, braided strap, and bus bars are to be brought to a bright finish and then coated with an antioxidant before connecting them.

Weight Considerations

A single OS6850 weighs approximately 14 lbs (6.24 Kgs). A stack of eight OS6850 switches weighs approximately 112 lbs (50 Kgs).

Items Included

Your OmniSwitch 6850 Series switch order includes the following items:

- OmniSwitch 6850 Series chassis
- Rack mount flanges with attachment screws (rack mount flanges may be pre-installed on some orders)
- Power cord (country-specific)
- Documentation CD containing a complete set of user guides for the switch and switch software. Refer to [“Related Documentation” on page 2](#) for a complete list of included documentation.

Depending on the items ordered for your specific network requirements, the following optional items may also be included:

- Stacking cables (per order)
- SFPs (per order)
- 10-Gigabit XFPs (per order)
- Backup power supply components and cables (per order)

Unpacking and Initial Setup

Unpacking the Chassis

To protect your OmniSwitch chassis and hardware components from electrostatic discharge (ESD) and physical damage, read all unpacking recommendations and instructions carefully before beginning.

Recommendations

- Unpack your OmniSwitch chassis as close as possible to the location where it will be installed.
- Depending on your order, Small Form-Factor Pluggables (SFPs), stacking cables and backup power supply components may be packaged separately. In order to greatly reduce exposure to electrostatic discharge (ESD) and physical damage, do not unpack these items until they are ready to be installed.

Instructions

- 1** Carefully cut the tape along the seam at the top of the box containing the chassis.
- 2** Lift the box’s top flaps. Remove any smaller boxes or pouches that are enclosed and set them aside.
- 3** Lift the chassis out of the packaging.

4 Carefully remove any foam pads and protective plastic from the switch chassis.

Note. Alcatel-Lucent provides factory-installed blank cover plates for empty backup power supply or 10-Giga-bit expansion module bays. Do not remove these cover plates unless a backup power supply or expansion module is to be installed immediately at the corresponding bay.

5 If you are installing multiple switches in a stacked configuration, repeat steps 1 through 4 for the remaining switches that will make up the stack.

6 Once all OmniSwitch 6850 Series switches have been removed from their packaging, continue to “Setting Up the Switch.”

Setting Up the Switch

Note. Due to their airflow and access requirements, OmniSwitch 6850 Series switches cannot be wall-mounted.

Airflow Considerations

Be sure that your switch is placed in a well-ventilated, static-free environment. Always allow adequate clearance at the front, rear, and sides of the switch.

The following diagram shows recommended minimum clearances for adequate chassis airflow and access to components at the rear of the chassis:

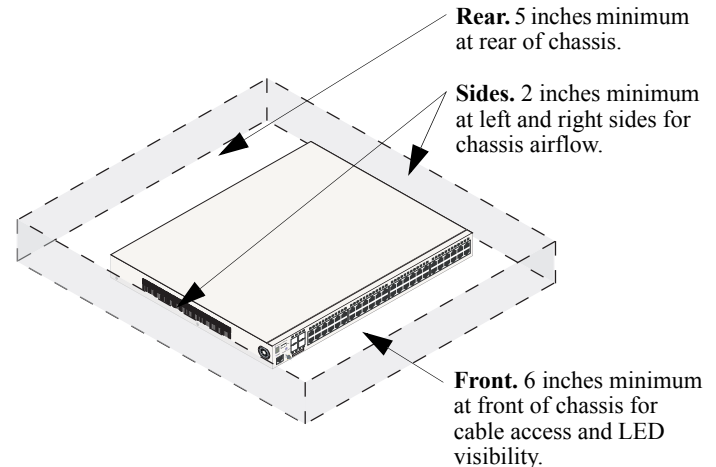

Chassis Top View

Never obstruct the air vents located at the left and right sides of the chassis.

Note. Clearance is not required at the top and bottom of the chassis. For detailed chassis airflow diagrams, refer to the *OmniSwitch 6850 Series Hardware Users Guide*.

Installation Options

There are two ways in which the OmniSwitch 6850 Series switches can be installed:

- Tabletop installation
- Rack-mount installation

For information on setting up a switch as a tabletop unit, refer to “Installing the Switch on a Tabletop or Bench.” For information on rack-mounting the switch, refer to “[Rack-Mounting the Switch](#)” on page 8.

Installing the Switch on a Tabletop or Bench

OmniSwitch 6850 Series switches can be installed freestanding as tabletop units. Place your switch on a stable, flat, and static-free surface.

Note. OmniSwitch 6850 Series switches must be placed “right side up.” Never attempt to operate a switch positioned on its side.

Tabletop Mounting Steps

To install the switch as a tabletop unit, follow the steps below:

- 1** Position the chassis on the table or bench where it is to be installed.
- 2** Be sure that adequate clearance has been provided for chassis airflow and access to the front, back, and sides of the switch. For recommended clearances, refer to [page 6](#). Also, be sure that you have placed the chassis within reach of all required AC power sources.

If you are placing multiple switches in a stacked configuration, carefully stack the remaining switches, one on top of the other. Up to eight switches may be stacked to form a single virtual chassis. Be sure to maintain adequate clearance at the front, rear, left, and right side of all switches (see [page 6](#)). Also, be sure that you have placed all switches in the stack within reach of required AC power sources.

Note. If you are installing a single (i.e., standalone) switch, continue to “[Connections and Cabling](#)” on page 11 for additional setup procedures.

Rack-Mounting the Switch

Refer to the important guidelines below before installing the OmniSwitch chassis in a rack.

- It is recommended that two people install the switch in the rack—one person to hold the chassis and position it in the rack, and a second person to secure the chassis to the rack using attachment screws (not supplied).
- Alcatel-Lucent provides two rack-mount flanges with each OmniSwitch 6850 Series switch. These flanges support standard 19-inch rack mount installations. These flanges must be attached to the chassis before the switch can be rack mounted.

Note. If you are installing the switch in a 23-inch wide rack, Alcatel-Lucent offers optional 23-inch rack-mounting hardware. For more information, contact your Alcatel-Lucent representative.

- Alcatel-Lucent does not provide rack-mount screws. Use the screws supplied by the rack vendor.
- To prevent a rack from becoming top heavy, it is recommended that you install heavier equipment at the bottom of the rack whenever possible.
- If you are installing the switch in a relay rack, be sure to install and secure the rack as per the rack manufacturer's specifications.

- Review [page 6](#) for important chassis airflow and access recommendations before installing.

Rack Mounting Steps

To rack-mount the switch, follow the steps below:

Note. Rack-mount flanges may come factory-installed in some cases. If this is the case, skip steps 1 and 2 below.

- 1** Align the holes in the provided rack-mount flanges with the four threaded holes in the OmniSwitch chassis. These threaded holes are located in the left and right sides of the chassis, near the front panel.
- 2** Attach the flanges to the chassis using the provided Phillips-head screws. Be sure to tighten each of the screws firmly using a Phillips screwdriver.

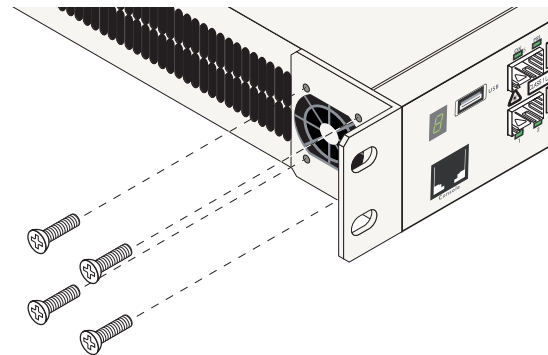

Attaching a Rack-Mount Flange

- 3** After the rack-mount flanges are secured to the chassis, mark the holes on the rack where the switch is to be installed.
- 4** Lift and position the switch until the rack-mount flanges are flush with the rack post.
- 5** Align the holes in the flanges with the rack holes that were marked in step 3.
- 6** Once the holes are aligned, insert a rack-mount screw (not provided) through the *bottom hole of each flange*. Tighten both screws until they are secure.

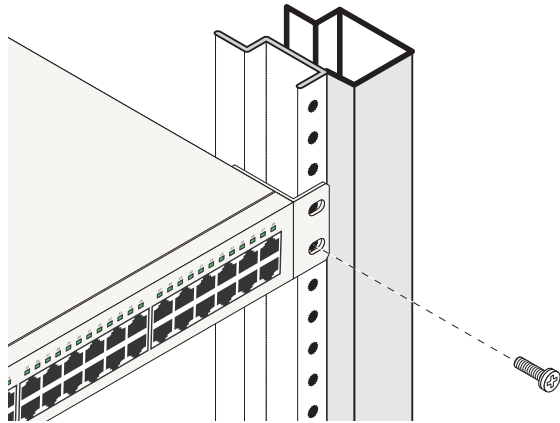

Attaching the Switch to the Rack

Note. Be sure to install the screws in the *bottom hole* of each flange, as shown, before proceeding.

7 Once the screws at the bottom of each flange are secure, install the remaining two rack-mount screws. Be sure that all screws are securely tightened.

8 If you are installing multiple switches in a rack to form a stacked configuration, repeat steps 1 through 7 for all switches in the stack.

Note. When rack mounting multiple switches in a stacked configuration, be sure to place all switches in vertically-adjacent rack positions. This will ensure that all required stacking cables will have adequate length for the installation.

Installing Combo Port SFPs

OmniSwitch 6850 Series switches offer Gigabit Ethernet combo ports, located on the front panel. These combo ports support hot-swappable fiber Small Form-Factor Pluggables (SFPs). For instructions on installing and removing combo port SFPs, refer to the instruction card provided with the SFP product.

Note. Combo port preferences are user-configurable via the system software. Refer to the “Configuring Ethernet Ports” chapter in the *OmniSwitch 6800/6850/9000 Network Configuration Guide* for complete details.

Note. For further details regarding supported SFP and XFP transceivers, refer to the *OmniSwitch Transceivers Guide*.

Installing Backup Power Supply Components

For detailed information on installing backup power supply components—including the backup power supply, connector cables, and power cords—refer to the *OmniSwitch 6850 Series Hardware Users Guide*.

For information on connecting stacked switches, refer to the *OmniSwitch 6850 Series Hardware Users Guide*.

Connections and Cabling

Once your switch is properly set up and all the required hardware components are installed, you should connect all network and management cables required for your network applications. Connections may include:

- RJ-45 cable connection to the console port
- Single mode or multimode fiber cables to combo port SFPs as required by your network
- Ethernet cables to 10/100/1000 or 10/100 Ethernet ports as required by your network

Connecting the Serial Cable

The console port, located on the chassis front panel, provides a serial connection to the switch and is required when logging into the switch for the first time. By default, this RJ-45 connector provides a DTE console connection.

Note. For stacked configurations, the serial cable should be connected to primary management module. If you are connecting the serial cable to a stack, it is advisable to wait until the stack has booted and the primary module has been dynamically assigned. Refer to the *OmniSwitch 6850 Series Hardware Users Guide* for more information.

Serial Connection Default Settings

The default settings for the serial connection are as follows:

baud rate	9600
parity	none
data bits (word size)	8
stop bits	1

Note. For information on modifying these settings, refer to the *OmniSwitch 6850 Series Hardware Users Guide*.

Booting OmniSwitch 6850 Series Switches

Booting a Standalone Switch

The OmniSwitch 6850 Series switch does not use an on/off switch. The power cord is the switch's only connect/disconnect device. The power connector socket is located on the switch's rear panel. For more information, refer to the *OmniSwitch 6850 Series Hardware Users Guide*.

To boot the switch, plug the power cord (provided) into the power connector socket at the switch's rear panel. Next, plug the power cord into an easily-accessible power source, such as a grounded AC outlet or an Uninterruptible Power Supply (UPS).

The switch immediately begins the boot process. Allow a few moments for the switch to boot completely, then verify the status of all LEDs on the switch's front panel. A successful boot for a standalone switch displays the following LED states:

LED States for a Standalone Switch

OK	Solid green
PRI	Solid green
PWR	Solid green

LED States for a Standalone Switch

BPS	Solid amber, if BPS attached is failed; off, if no operational BPS is attached; solid green if an operational BPS is attached and operating normally.
XFP1	Off (applies to all OmniSwitch 6850 Series switches except for the OmniSwitch 6850-24X, OmniSwitch 6850-P24X, OmniSwitch 6850-48X, OmniSwitch 6850-P48X, and OmniSwitch 6850-U24X).
XFP2	Off (applies to all OmniSwitch 6850 Series switches except for the OmniSwitch 6850-24X, OmniSwitch 6850-P24X, OmniSwitch 6850-48X, OmniSwitch 6850-P48X, and OmniSwitch 6850-U24X).
Slot Indicator	1–8 (non-blinking), depending on the slot number value in the boot.slot.cfg file. See the <i>OmniSwitch 6850 Series Hardware Users Guide</i> for detailed information. The default value is 1.

If any of the LED state differs from the states shown in the table above, refer to the *OmniSwitch 6850 Series Hardware Users Guide* for more information. Contact Alcatel-Lucent Customer Support if the unexpected LED state persists.

For information on booting stacked configurations and dynamic slot numbering, refer to the *OmniSwitch 6850 Series Hardware Users Guide*.

Your First Login Session

Once the switch or stack has successfully booted and you have accessed your computer's terminal emulation software via the console port, you are ready to log in to the switch's Command Line Interface (CLI) and configure basic information.

Complete the following steps during your first login session:

- Log in to the switch or stack
- Unlock session types
- Change the login password
- Set the date and time
- Set optional system information
- Save your changes

Note. You must be connected to the switch via the *console port* before initiating your first login session. If you are using OmniSwitch 6850 Series switches in a stacked configuration, you must be connected to the console port of the stack's primary switch.

Logging in to the Switch

When you first log in to the switch or stack, you will be prompted for a login (i.e., *user*) name and password. During this first login session, only one user name option and one password option is available:

- Login (i.e., user name)—**admin**
- Password—**switch**

To log in to the switch or stack, enter **admin** at the login prompt:

```
login: admin
```

Next, enter the factory default password, **switch**, at the password prompt:

```
password: switch
```

The default welcome banner, which includes information such as the current software version and system date, displays— followed by the CLI command prompt:

```
Welcome to the Alcatel-Lucent OmniSwitch 6850 Series
Software Version 6.1.5.281.R01 Development, March 16, 2007.

Copyright(c), 1994-2007 Alcatel-Lucent All Rights reserved.

OmniSwitch(TM) is a trademark of Alcatel-Lucent registered
in the United States Patent and Trademark Office.

->
```

More Information on User Accounts. A user account includes a login name, password, and user privileges. Privileges determine whether the user has read or write access to the switch and which commands the user is authorized to execute.

For detailed information on setting up and modifying user accounts and user privileges, refer to the “Managing Switch User Accounts” chapter of your *OmniSwitch 6800/6850/9000 Switch Management Guide*.

Assigning an IP Address to the Switch

Assigning an IP address to your OmniSwitch 6850 Series switch is an important step in the setup process.

Remote sessions such as Telnet, FTP, and WebView require an IP address. The IP address for these session types serves as a destination point for the remote session. Therefore, before the switch can support any remote login sessions, a valid IP address must be configured.

To assign an IP address to a switch, simply assign an IP address to the switch’s default VLAN 1 by entering the **ip interface** command at the CLI prompt. Be sure that the command begins with the command syntax:

```
-> ip interface address
```

exactly as shown, followed by the IP address. For example:

```
-> ip interface vlan_1 address 172.2.120.1
vlan 1
```

For information on assigning IP addresses in a stacked configuration, refer to the *OmniSwitch 6850 Hardware Users Guide*.

Unlocking Session Types

Security is a key feature on OmniSwitch 6850 Series switches. As a result, when you access the switch for the first time, you must use a *direct console port connection*. All other session types (Telnet, FTP, WebView, SNMP, etc.) are “locked out” until they are manually unlocked by the user.

The CLI command used to unlock session types is **aaa authentication**.

Note. When you unlock session types, you are granting switch access to non-local sessions (e.g., Telnet). As a result, users who know the correct user login and password will have remote access to the switch. For more information on switch security, refer to the “Managing Switch User Accounts” chapter of your *OmniSwitch 6800/6850/9000 Switch Management Guide*.

Unlocking All Session Types

To unlock all session types, enter the following command syntax at the CLI prompt:

```
-> aaa authentication default local
```

Unlocking Specified Session Types

You can also unlock session types on a one-by-one basis. For example, to unlock Telnet sessions only, enter the following command:

```
-> aaa authentication telnet local
```

To unlock WebView (HTTP) sessions only, enter the following command:

```
-> aaa authentication http local
```

You cannot specify more than one session type in a single command line. However, you can still unlock multiple session types by using the **aaa authentication** command in succession. For example:

```
-> aaa authentication http local  
-> aaa authentication telnet local  
-> aaa authentication ftp local
```

Changing the Login Password

Change the login password for **admin** user sessions by following the steps below:

- 1 Be sure that you have logged into the switch as user type **admin** (see “[Logging in to the Switch](#)” on page 14).
- 2 Enter the keyword **password** and press **Enter**.
- 3 Enter your new password at the prompt (refer to the note below).

Note. Typically, the password should be a string of non-repeating characters. The switch’s authentication software uses the first occurrence of the character series to uniquely identify the password. For example, the password *engreng* is the same as *engr*. A better password might be *engr2735*.

- 4 You will be prompted to re-enter the password. Enter the password a second time.

Note. Be sure to remember or securely record all new passwords; overriding configured passwords on OmniSwitch 6850 Series switches is restricted.

New password settings are automatically saved in real time to the local user database; the user is not required to enter an additional command in order to save the password information. Also note that new password information is retained following a reboot.

All subsequent login sessions—including those through the console port—will require the new password in order to access the switch.

User Accounts. The switch allows a maximum of 50 user accounts in the local user database. For information on creating additional user types and assigning individual passwords, refer to the “Managing Switch User Accounts” chapter of your *OmniSwitch 6800/6850/9000 Switch Management Guide*.

Setting the System Time Zone

The switch's default time zone is UTC (also referred to as Greenwich Mean Time).

If you require a time zone that is specific to your region—or if you need to enable Daylight Savings Time (DST) on the switch—you can configure these settings via the **system timezone** and **system daylight savings time** commands. For example, to set the system clock to run on Pacific Standard Time, enter the following command:

```
-> system timezone pst
```

To enable Daylight Savings Time, enter the following command:

```
-> system daylight savings time enable
```

Many other time zone variables are supported. For detailed information on configuring a time zone for the switch, refer to your *OmniSwitch 6800/6850/9000 Switch Management Guide*.

Setting the Date and Time

Set the current time for the switch by entering **system time**, followed by the current time in *hh:mm:ss*. For example:

```
-> system time 18:35:00
```

The switch uses a 24-hour clock; the time value shown in the above example would set the time to 6:35 PM.

To set the current date for the switch, enter **system date**, followed by the current date in *mm/dd/yyyy*. For example:

```
-> system date 06/27/2005
```

Setting Optional System Information

This section provides information on configuring optional system parameters, including:

- the switch's administrative contact
- a system name
- the switch's physical location

Specifying an Administrative Contact

An administrative contact is the person or department in charge of the switch. If a contact is specified, users can easily find the appropriate network administrator if they have questions or comments about the switch.

To specify an administrative contact, enter **system contact**, followed by a text string of up to 254 characters. If you include spaces between words in the text string, be sure to enclose the string in quotes (" ").

For example:

```
-> system contact "JSmith js@company.com"
```

Specifying a System Name

The system name is a simple, user-defined text description for the switch.

To specify a system name, enter **system name**, followed by a text description of up to 19 characters.

Note. You *cannot* include spaces between words when entering a system name.

For example:

```
-> system name EngSwitch3
```

Specifying the Switch's Location

It is recommended that you use a physical labeling system for locating and identifying your switch(es). Examples include placing a sticker or placard with a unique identifier (e.g., the switch's default IP address) on each chassis.

However, if no labeling system has been implemented *or* if you need to determine a switch's location from a remote site, entering a system location can be very useful.

To specify a system location, enter **system location**, followed by a text description of up to 254 characters. If you include spaces between words in the text string, be sure to enclose the string in quotes (" ").

For example:

```
-> system location "NMS Lab--NE Rack"
```

Viewing and Saving Changes

To view your current changes, enter **show system** at the CLI prompt.

Once you have configured this basic switch information, save your changes by entering **write memory** at the CLI command prompt.

When the **write memory** command is entered, changes are automatically saved to the main configuration file (**boot.cfg**) and placed in the **/flash/working** directory. For more information on the **boot.cfg** file, refer to [page 20](#).

Note. If the switch reboots following a **write memory** command entry, the switch will run from the **/flash/certified** directory. As a result, subsequent configuration changes cannot be saved using the **write memory** command until the switch is once again running from the **/flash/working** directory. See [page 22](#) for important information on these directories.

This completes the initial configuration process. Your OmniSwitch 6850 Series switch is now ready for additional configuration and network operation. Refer to the following sections for more information on using your switch, as well as additional built-in features.

For stacked configurations, be sure to refer to the *OmniSwitch 6850 Series Hardware Users Guide*.

Files and Directories

Boot and Image Files

Although the flash memory on OmniSwitch 6850 Series switches can contain many file types (e.g., log and snapshot files), there are four specific file types that provide key switch and network functions. These files include the **boot.cfg** file, **boot.params** file, **boot.slot.cfg** file, and image (.img) files.

boot.params File

The **boot.params** file provides IP address, gateway, and mask information for the switch. This information is required for Ethernet connections to the switch.

This file also contains default console port parameters (baud rate, etc.) and can be modified via the **modify boot parameters** CLI command.

In order to be read by the switch, the **boot.params** file must be placed in the **/flash** directory. If the file is deleted for any reason, a new **boot.params** file will be automatically generated on the next system boot. However, all user-configured information, such as IP address, gateway, and mask information, will be lost. Therefore, it is recommended that you keep a backup copy of this file at all times.

boot.cfg File

The **boot.cfg** file stores your network configuration parameters. When you first boot the switch, no **boot.cfg** file is present. This file is automatically generated when you first issue a **write memory** command to save your configuration changes. The file is then automatically placed in the **/flash/working** directory.

Important. Your switch must be running from the **/flash/working** directory in order to save changes to the **boot.cfg** file. Refer to “[Working and Certified Directories](#)” on page 22 for more information.

Once the configuration parameters stored in the **boot.cfg** file are considered tested and reliable, the file can be copied to the **/flash/certified** directory and become part of the “last known good” software for the switch.

If all copies of this file are deleted and a system boot occurs, your network configuration will be lost. Therefore, it is recommended that you keep a backup copy of this file at all times.

Image Files

Image files (those files with **.img** extensions) contain an executable code that provides support for the system, Ethernet ports, and network functions. In other words, they serve as essential drivers for switch and network operations.

Although these files may be backed up to the root flash directory or any user-defined subdirectory, they must be present in the **/flash/working** and **/flash/certified** directories for the switch to operate and pass traffic.

If you delete all copies of an image file, you will be required to contact Alcatel-Lucent Customer Support for replacements. Therefore, it is recommended that you keep backup copies on your computer's hard drive or a locally-accessible server.

For a complete list of OmniSwitch 6850 Series image files, along with their functions, refer to the following table:

K2os.img	Contains the OmniSwitch 6850 Series operating system software.
Kbase.img	Contains base code for the switch.
Krelease.img	Contains release number information for the system software package.
Keni.img	Provides support for 10/100/1000 and Gigabit Ethernet.
Kadvrout.img	Alcatel-Lucent's Advanced Routing software package. Optional.
Ksecu.img	Provides enhanced security features for the switch, such as Authenticated VLANs (AVLANs).
K2diag.img	Provides enhanced hardware diagnostics for the switch.

Working and Certified Directories

OmniSwitch 6850 Series switches offer flash memory with 8 MB base ROM space and 64 MB extended ROM. This memory is used to store files, including boot and image files, that are used for switch operations.

The **/flash** directory contains two subdirectories: **/working** and **/certified**. These directories work together to provide the *image rollback* resiliency feature. Image rollback allows the switch to return to a prior “last known good” version of software in the event of a system software problem.

Working Directory

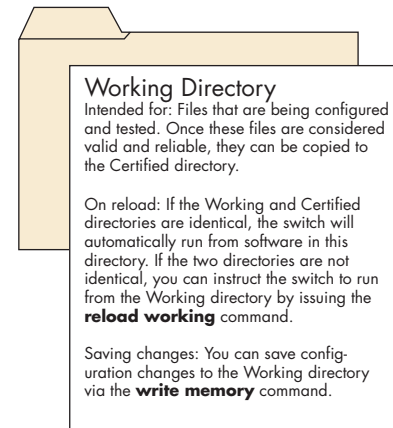

The **/flash/working** directory is intended for software that is still being configured for your network. Changes made while configuring your switch are saved to the **boot.cfg** file in the **/flash/working** directory.

Once the **/flash/working** directory’s configuration and image files are road-tested and considered valid and reliable for your network, they can be copied to the **/flash/certified** directory.

Certified Directory

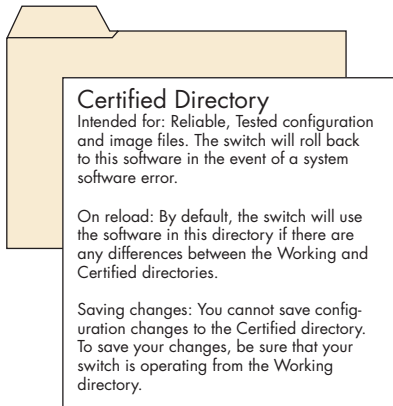

The software in the **/flash/certified** directory should be treated as the “gold master” for the switch. When you place configuration and image files in this directory, you are “certifying” them as tested and reliable. If the switch is running from the **/flash/working** directory and experiences a software problem, it will “roll back” to the last known good software in the **/flash/certified** directory on the next reboot.

How can I tell which directory the switch is currently using?

When you first boot the switch, the **/flash/working** directory is used; this allows you to save your initial configuration changes to the **boot.cfg** file. However, subsequent boots may result in your switch running from the **/flash/certified** directory. Therefore, verifying the current running directory is a key step any time you are configuring or monitoring the switch.

View the switch’s current running directory by entering the **show running-directory** command. For example:

```
-> show running-directory

CONFIGURATION STATUS
  Running CMM                : PRIMARY,
  CMM Mode                    : DUAL CMMs,
  Current CMM Slot           : 1,
  Running configuration      : WORKING,
  Certify/Restore Status     : CERTIFY NEEDED
SYNCHRONIZATION STATUS
  Flash Between CMMs        : SYNCHRONIZED,
  Running Configuration     : NOT AVAILABLE,
  Stacks Reload on Takeover: ALL STACKs (SW
Activation)
```

In this example, the switch is using the **/flash/working** directory. For more information on the **show running-directory** command output, refer to the “CMM Commands” chapter in the *OmniSwitch CLI Reference Guide*.

Can I save changes to the Certified directory?

No. The **/flash/certified** directory is intended to store only tested, reliable configuration and image files. Configuration changes must be saved to the **boot.cfg** file in the **/flash/working** directory. Once those changes have been road-tested, the contents of the **/flash/working** directory can be copied to the **/flash/certified** directory via the **copy working certified** command.

What happens when the switch boots?

During the boot process, the switch compares the contents of the **/flash/working** and **/flash/certified** directories. Based on this comparison, the switch determines which directory to use as its running software.

Working and Certified Are Identical

If the software in the **/flash/working** and **/flash/certified** directories are completely identical, the switch considers the software in both directories to be equally reliable. In this case, the switch will run from the **/flash/working** directory.

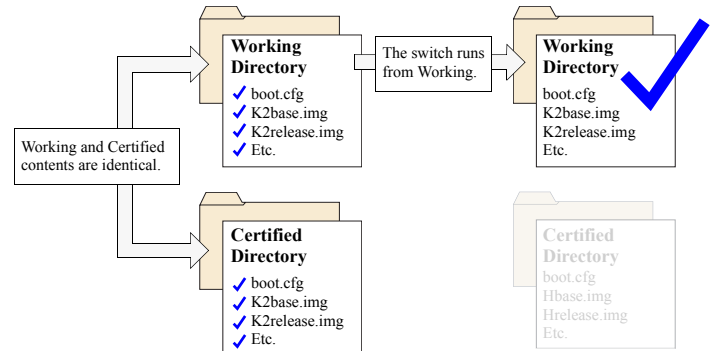

When the switch is running from the **/flash/working** directory software, configuration changes can be saved via the **write memory** command.

Working and Certified Are Different

If the software in the `/flash/working` directory differs *even slightly* from the software in the `/flash/certified` directory, the switch will automatically run from the `/flash/certified` directory.

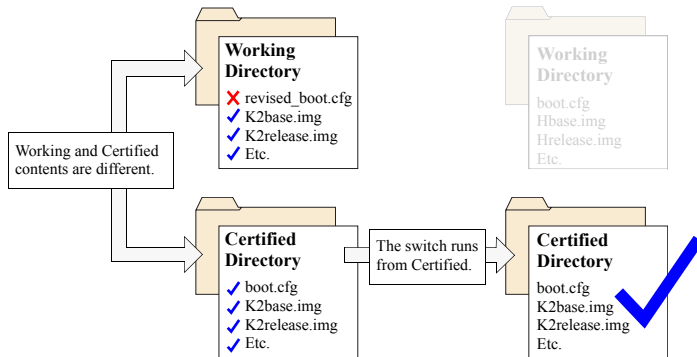

When the switch runs from the `/flash/certified` directory, configuration changes *cannot* be saved via the **write memory** command.

My Working and Certified directories are different. Can I force a reboot from the Working directory?

Yes. If its configuration and image files are known to be reliable, you can override the default and initiate a reboot from the `/flash/working` directory. This is done via the **reload working** command. For more information, refer to your *OmniSwitch CLI Reference Guide*.

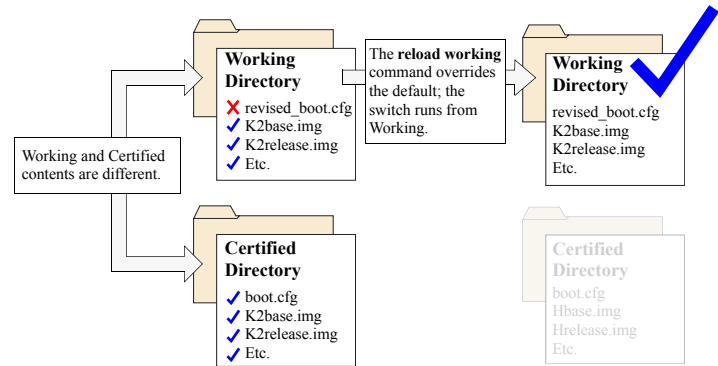

Note. For detailed information on using directories, refer to the “Managing CMM Directory Content” chapter in the *OmniSwitch 6800/6850/9000 Switch Management Guide*.

Using WebView

The switch can be configured and monitored using WebView, Alcatel-Lucent's Web-based device management tool.

WebView software is pre-installed in the switch; you are not required to load additional software.

Note. Although WebView software is pre-installed, you must first enable HTTP sessions for your switch before you can log in. Refer to [“Unlocking Session Types” on page 16](#) for more information.

Browser Compatibility

The following Web browsers are recommended for use with WebView:

- Internet Explorer 6.0 and later for Windows NT, 2000, XP, 2003
- Netscape 7.1 for Windows NT, 2000, XP
- Netscape 7.0 for Solaris SunOS 5.8

Logging In to WebView

Note. Before attempting to establish a WebView session, be sure that you have first unlocked the HTTP session type via the **aaa authentication** command. Otherwise, a login error will occur. See [“Unlocking Session Types” on page 16](#) for more information.

To access WebView and log in to a switch:

- 1 Open any Alcatel-Lucent-tested Web browser.

2 Enter the switch's IP address in the browser's "Address" text field ("Location:" for Netscape users). The login screen displays.

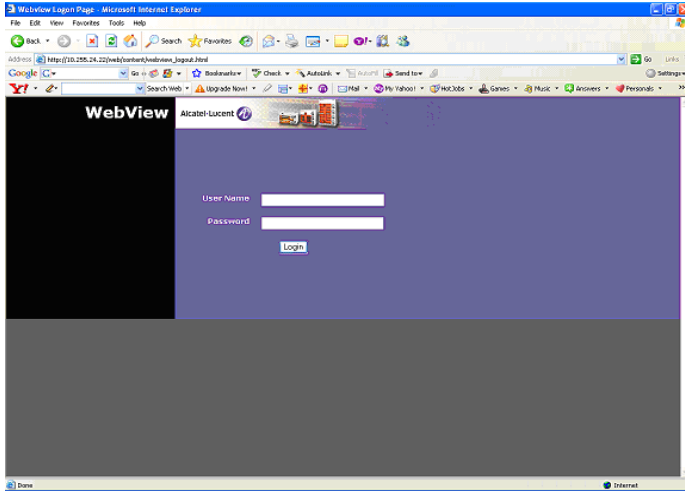

3 Enter the user name and password at the login prompt.

Remember, if you have already changed the user name and password for your switch, be sure to use the new information. If you have not changed your user name or password, the factory defaults are **admin** and **switch**, respectively. Refer to the "Managing Switch User Accounts" chapter of your *OmniSwitch 6800/6850/9000 Switch Management Guide* for information on modifying the default user name and password.

Navigating WebView

After you have successfully logged in, the Chassis Management home page displays.

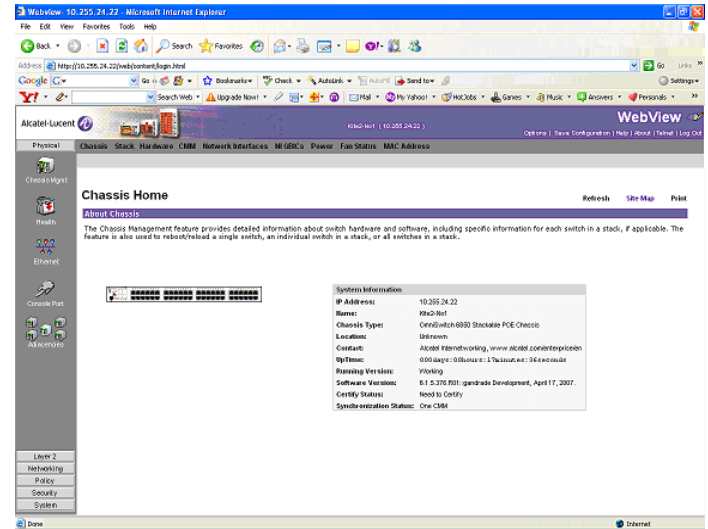

The Chassis Management home page provides a physical representation of the switch, as well as basic system information. This is the main launching point for WebView.

Navigate the application by clicking on the “Configuration Group” buttons in the left-hand toolbar.

Main “Configuration Group” Toolbar.

(In this case, the group “Health” has been selected.)

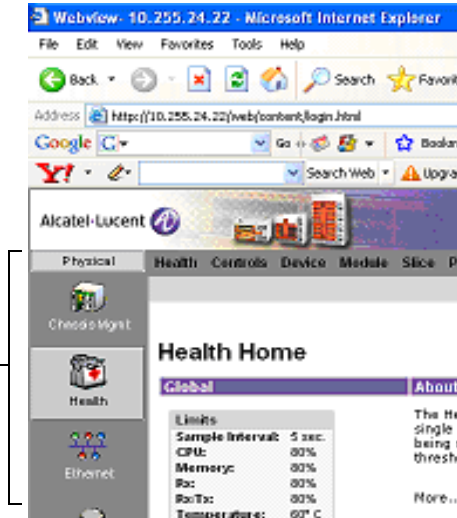

Refine your navigation by selecting “Configuration Options” for each group from the items displayed in the grey, horizontal navigation bar.

“Configuration Options” Toolbar.

(In this case, the option “Device” has been selected.)

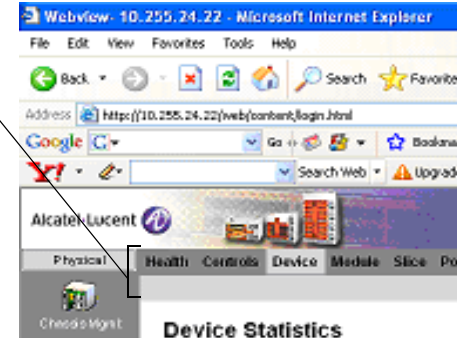

Site Maps. WebView also provides site maps for each configuration group. Site maps allow you to view complete page contents under each feature. By providing quick, easy access to specific pages, site maps can reduce time spent searching through the WebView application. To access site maps, click the “Site Map” link included on each configuration group Home page, (e.g., Health).

Online Help

General online help is available through the main Help link located in the top WebView banner.

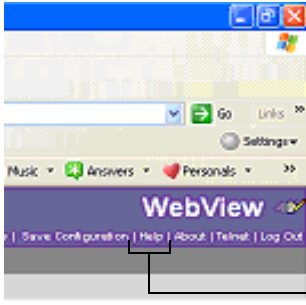

General Help Link

Detailed, context-based help is provided for each status table and configuration dialog window.

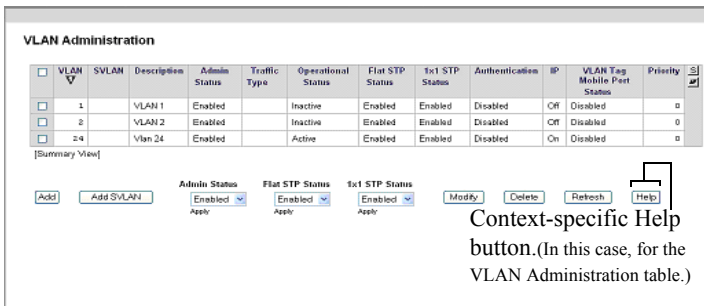
A screenshot of the 'VLAN Administration' interface. It features a table with columns for VLAN ID, SVLAN, Description, Admin Status, Traffic Type, Operational Status, Flat STP Status, 1x1 STP Status, Authentication, IP, VLAN Tag Mobile Port Status, and Priority. Below the table, there are several control buttons: 'Add', 'Add SVLAN', 'Admin Status' (Enabled), 'Flat STP Status' (Enabled), '1x1 STP Status' (Enabled), 'Modify', 'Delete', 'Refresh', and 'Help'. A line points from the 'Help' button to the text 'Context-specific Help button. (In this case, for the VLAN Administration table.)'.

VLAN	SVLAN	Description	Admin Status	Traffic Type	Operational Status	Flat STP Status	1x1 STP Status	Authentication	IP	VLAN Tag Mobile Port Status	Priority
<input type="checkbox"/>	1	VLAN 1	Enabled		Inactive	Enabled	Enabled	Disabled	Off	Disabled	0
<input type="checkbox"/>	2	VLAN 2	Enabled		Inactive	Enabled	Enabled	Disabled	Off	Disabled	0
<input type="checkbox"/>	24	Vlan 24	Enabled		Active	Enabled	Enabled	Disabled	On	Disabled	0

Context-specific Help button. (In this case, for the VLAN Administration table.)

Additional Information

For more information on using WebView, refer to the “Using WebView” chapter in the *OmniSwitch 6800/6850/9000 Switch Management Guide*.

Troubleshooting

The WebView login screen does not display.

This suggests either a physical or network connection issue. Try the following options:

- Be sure that you have a good physical Ethernet cable connection to the switch.
- Be sure your computer has a valid Ethernet connection and IP address.
- Verify that all required WebView image files are installed in the current running directory. See [page 26](#) for more information.

The login screen displays, but the login fails.

This suggests either a user name and password or Authenticated Switch Access error. Try the following options:

- Check that you are using the correct user name and password. If you have already changed the user name and password for your switch, be sure to use the new information. If you have not changed the user name and password, the factory defaults are **admin** and **switch**, respectively.
- Be sure that you have “unlocked” HTTP sessions on the switch. To unlock HTTP sessions, enter the following command:

```
-> aaa authentication http local
```

See [page 16](#) for information on unlocking session types.